

TRUSTILE[®]
A MARVIN[®] BRAND

THE EXCEPTIONAL ENTRANCE
DRIVEN BY DESIGN[®]





THE TRUSTILE STORY

Since 1995, TruStile has led the way in design-driven interior doors, enhancing custom homes all over the United States.

After years of collaboration with our parent company Marvin, we're bringing our mission for inspiring design to the front of the home.

The result is an extensive Entry System offering that is unmatched, easy to specify and backed by industry-leading quality. Make the entry to

your new home a most welcoming invitation with TruStile.

THE DESIGN FLEXIBILITY AND PRODUCT
EXCELLENCE
BREADTH WE PIONEERED FOR THE INTERIOR
IN ENTRY
OF THE HOME IS NOW READY TO CREATE
SYSTEMS
THE MOST ENCHANTING ENTRANCES.



TABLE OF CONTENTS

TruStile Selection Guide	5
Architectural Styles Overview	7
Modern	9
Traditional	31
Modern Farmhouse	45
French Country	55
Coastal	65
Mediterranean	75
Craftsman	85
Cape Cod	95
Style Reference Guide	105
Construction & Product Details	117
Warranty, Care & Maintenance	125

TRUSTILE ENTRY SYSTEMS

ORGANIZED

SIMPLIFIED

CUSTOMIZED

Wood is a natural product and the finish and color will vary depending on the wood species and lighting on the job site. The images printed within this catalog are a representation of TruStile species and stain colors and do not replace seeing the stain and wood samples in person. Please visit your local TruStile dealer to request a factory finished stain sample.

TRUSTILE ENTRY SYSTEMS

Two Ways to Create Your Entry System

Select From Our Featured Entry Systems

We've created over 80 featured entry systems that capture the current trends of popular architectural styles. Start with the style most closely matching your vision for your home and tailor it to match your tastes and requirements.

Select From Over 80 Featured Entry Systems

See all options in each architectural section.

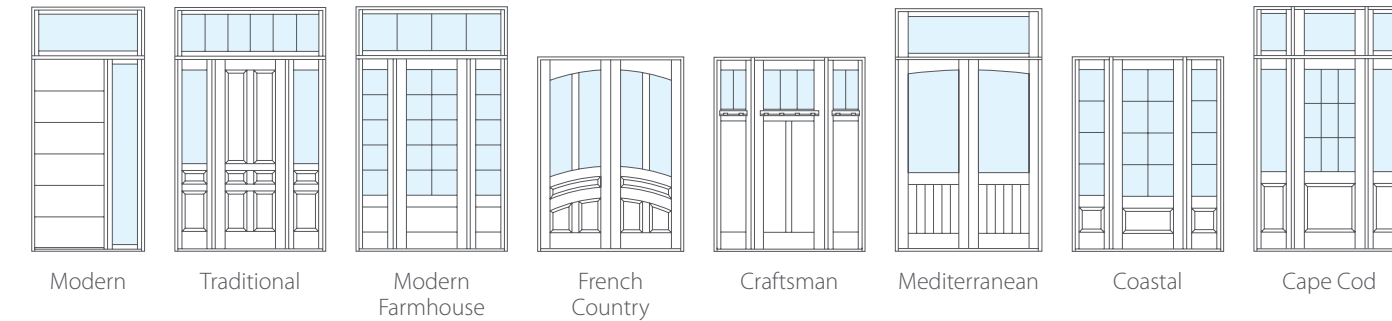

Take your selection to your local dealer to finalize details such as materials and wood species.



Or Build Your Own Entry System

Designing your custom entry system is now as easy as 1, 2, 3. Select from over 500 door styles and endless design options. Then finalize the details to your exact specifications.

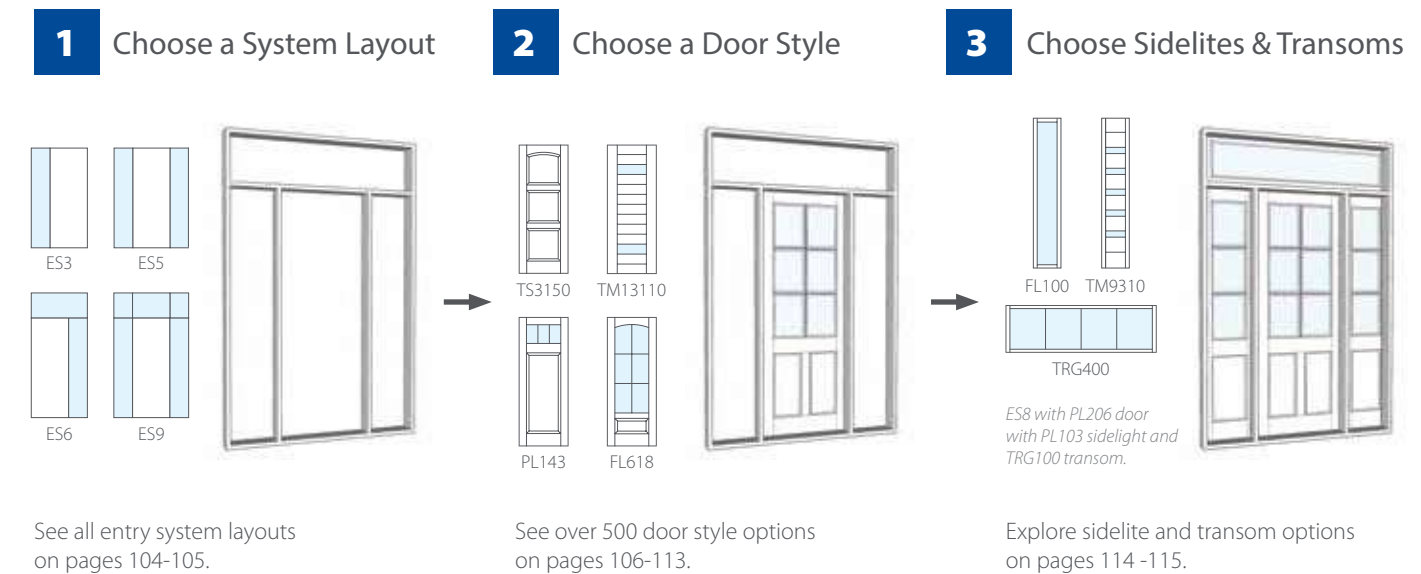

Our Door Design Tool lets you configure every detail of your entry system online. Save your projects and get connected with a local dealer for budget numbers.

Start designing at trustile.com/designtool.

Find a dealer near you at trustile.com/dealers.



MODERN



TRADITIONAL



MODERN FARMHOUSE



FRENCH COUNTRY



COASTAL*

*Architectural Category Only. Impact and Hurricane ratings not currently available. See your TruStile dealer to verify compatibility with your local building code.



MEDITERRANEAN



CRAFTSMAN



CAPE COD

ARCHITECTURAL STYLES

IMPACTFUL
SOPHISTICATED
AUTHENTIC

TruStile has curated over 80 featured designs across eight architectural styles to make it easy to find the right look for your new entrance.



MODERN

SLEEK
CONTEMPORARY
STRIKING

System Code	TMIR6001-102B
Layout	ES102
Door Style	TMIR6001
Sidelite	DSG100
Profile	1/4" Kerf Cut Reveal
Wood Species	Mahogany
Finish	White Haze
Glass	Clear

Reverse configuration shown with Right Handing.



MODERN

System Code	TMF1000-103B
Layout	ES103
Door Style	TMF1000
Sidelite	DSG100
Wood Species	Mahogany
Finish	Ebony
Glass	White Lami



MODERN

System Code	TMIR9001-108A
Layout	ES108
Door Style	TMIR9001
Sidelite	FL100
Transom	TRG100
Profile	1/4" Kerf Cut Reveal
Wood Species	Mahogany
Finish	Slate
Glass	Clear

MODERN

System Code	TM9340-105C
Layout	ES105
Door Style	TM9340
Sidelite	TM9340
Profile	1/4" Kerf Cut Reveal
Wood Species	Rift Sawn White Oak
Finish	Grey Mist
Glass	White Lami





MODERN

System Code	TMIR1002-102B
Layout	ES102
Door Style	TMIR1002
Sidelite	DSG100
Profile	1/4" Kerf Cut Reveal
Wood Species	Walnut
Finish	Ebony
Glass	Clear

MODERN

System Code	TM6100-105A
Layout	ES105
Door Style	TM6100
Sidelite	TM1000
Profile	SS Sticking
Wood Species	Rift Sawn White Oak
Finish	White Haze
Glass	Clear





MODERN

System Code	TMIR6000-106B
Layout	ES106
Door Style	TMIR6000
Sidelite	DSG100
Transom	DSG100
Profile	1/4" Kerf Cut Reveal
Wood Species	Mahogany
Finish	Cinnamon
Glass	Clear



MODERN

System Code	TMIR5101-103B
Layout	ES103
Door Style	TMIR5101
Sidelite	DSG100
Profile	1/4" Kerf Cut Reveal
Wood Species	Mahogany
Finish	Slate
Glass	White Lami



MODERN

System Code	TMF1000-103A
Layout	ES103
Door Style	TMF1000
Sidelite	FL100
Wood Species	Plain Sawn White Oak
Finish	Nutmeg
Glass	Clear

MODERN

System Code	TM9350-105A
Layout	ES105
Door Style	TM9350
Sidelite	FL100
Profile	1/4" Kerf Cut Reveal
Wood Species	Walnut
Finish	Ebony
Glass	Clear



Choose One of Our **Featured Entry Systems**

Designed by TruStile and ready to order through your local dealer.

Or Customize Your Own Entry System

Follow these simple steps to design your own unique entry system.

MODERN

Featured Modern Entry Systems in this Catalog

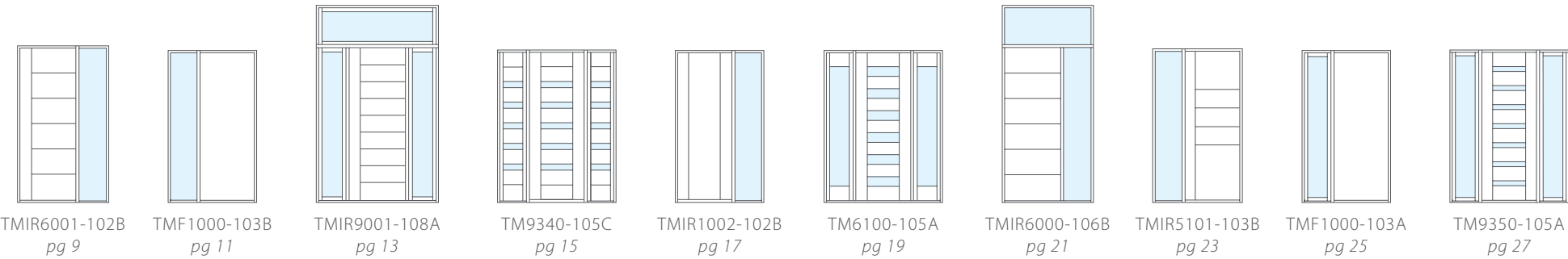

Other Featured Modern Entry Systems



1 Choose Your Entry System Layout

See pages 104-105 for additional configurations.

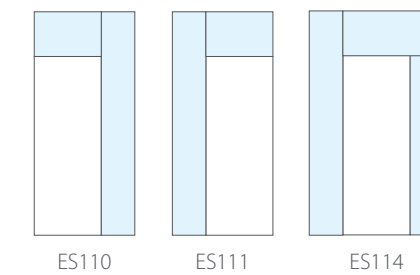
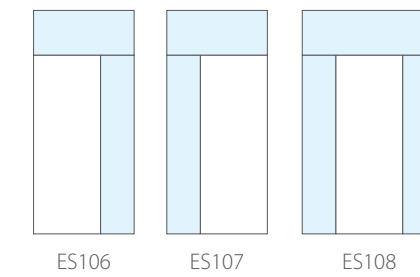
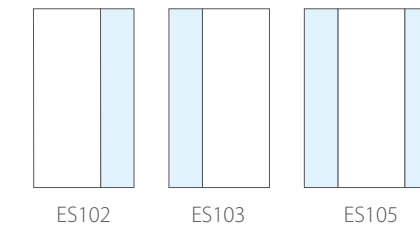

2 Select Your Door Style

TM Series (see pages 106-107)

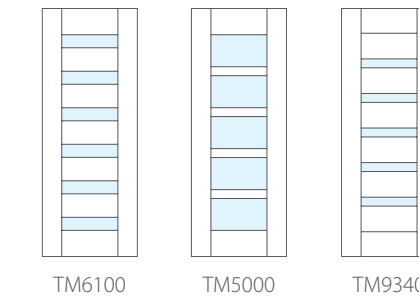

TMIR Series (see page 107)

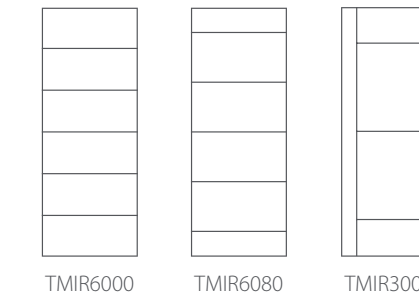

TMF Series (see page 107)

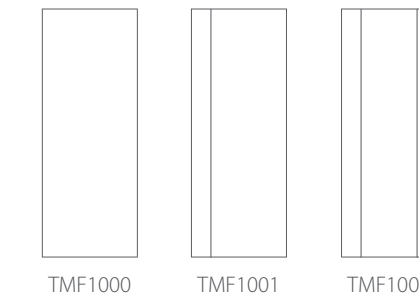

3 Choose Your Sidelites and Transoms

FL Series

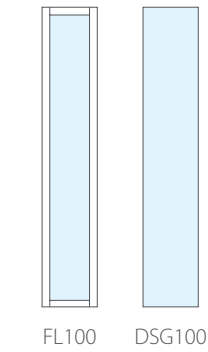

TM Series

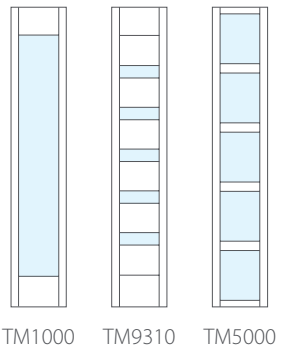

(see pages 114-115 for sidelite and transom details)

TRG Series





TRADITIONAL

CLASSIC

POLISHED

TIMELESS

System Code	TS4300-308C
Layout	ES308
Door Style	TS4300
Sidelite	PL220
Transom	TRG110
Profile	SS Sticking/C Panel
Wood Species	Rift Sawn White Oak
Finish	Hazelnut
Glass	Clear

Door top panels substituted for glass.

TRADITIONAL

System Code	TS3000-109D
Layout	ES109
Door Style	TS3000
Sidelite	FL300
Transom	TRG100
Profile	QB Sticking/B Panel
Wood Species	Mahogany
Finish	Nutmeg
Glass	Clear





TRADITIONAL

System Code	FL616-109C
Layout	ES109
Door Style	FL616
Sidelite	FL310
Transom	TRG100 and TRG200
Profile	SS Sticking/C Panel
Wood Species	Plain Sawn White Oak
Finish	Hazelnut
Glass	Clear

TRADITIONAL

System Code	TS6020-108D
Layout	ES108
Door Style	TS6020
Sidelite	TS3070
Transom	TRG600
Profile	OG Sticking/D Panel
Wood Species	Mahogany
Finish	Ebony
Glass	Clear



Sidelite top panels replaced with glass.



TRADITIONAL

System Code	TS3100-109C
Layout	ES109
Door Style	TS3100
Sidelite	FL110
Transom	TRG100
Profile	OS Sticking/A Panel
Wood Species	Paint-Grade Mahogany
Paint Color	SW 6990 Caviar
Glass	Clear



TRADITIONAL

System Code	TS4060-504A
Layout	ES504
Door Style	TS4060
Transom	TRG110
Profile	CB Sticking/B Panel
Wood Species	Mahogany
Finish	Cinnamon
Glass	Clear

Choose One of Our **Featured Entry Systems**

Designed by TruStile and ready to order through your local dealer.

Or Customize Your Own Entry System

Follow these simple steps to design your own unique entry system.

TRADITIONAL

Featured Traditional Entry Systems in this Catalog

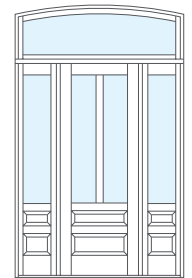

TS4300-308C
pg 31

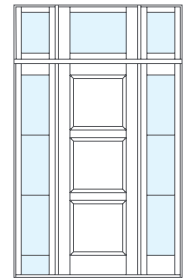

TS3000-109D
pg 33

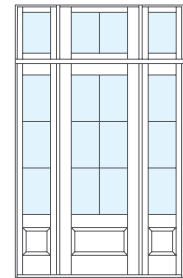

FL616-109C
pg 35

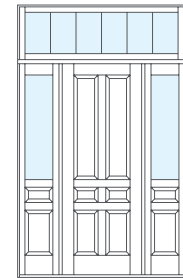

TS6020-108D
pg 37

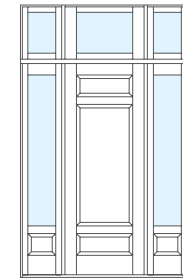

TS3100-109C
pg 39

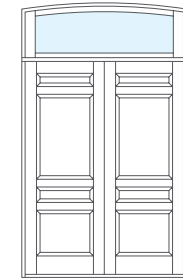

TS4060-504A
pg 41

Other Featured Traditional Entry Systems

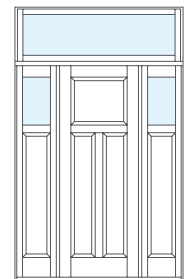

TS3300-108C
online

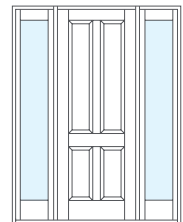

TS4000-105A
online



TS3280-104D
online



TS3160-504A
online

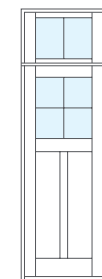

PL234-104C
online

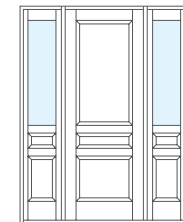

TS3070-105C
online

1 Choose Your Entry System Layout

See pages 104-105 for additional configurations

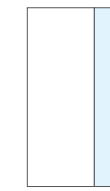

ES102



ES104

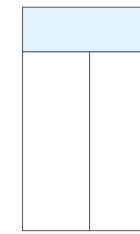

ES204

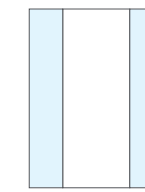

ES105

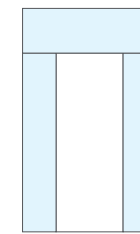

ES108

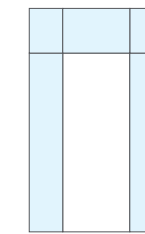

ES109

2 Select Your Door Style

TS Series (see pages 112-113)

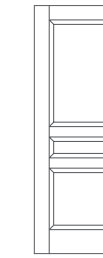

TS3070

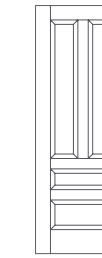

TS4300

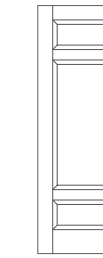

TS3100

FL Series (see pages 108-109)

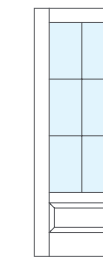

FL616

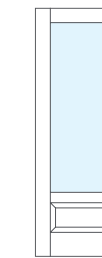

FL110

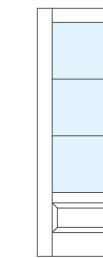

FL310

PL Series (see pages 110-111)

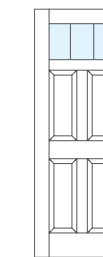

PL443



PL220

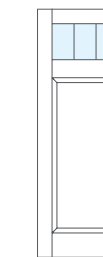

PL144

3 Choose Your Sidelites and Transoms

FL Series

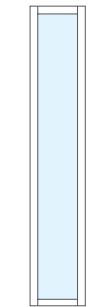

FL100

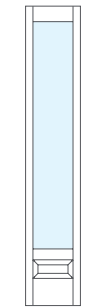

FL110

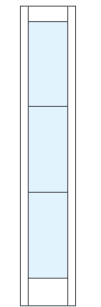

FL300

PL Series

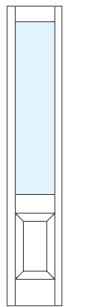

PL100

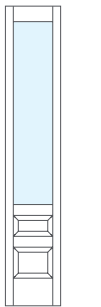

PL220

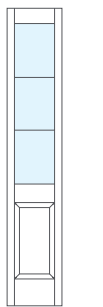

PL103

(see pages 114-115 for sidelite and transom details)

TRG Series

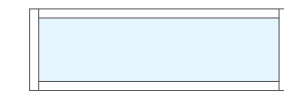

TRG100

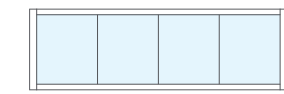

TRG400



MODERN FARMHOUSE

FRESH
RELAXED
UPDATED

System Code	PL206-108C
Layout	ES108
Door Style	PL206
Sidelite	PL103
Transom	TRG100
Profile	SS Sticking/C Panel
Wood Species	Walnut
Finish	Ebony
Glass	Clear

MODERN FARMHOUSE

System Code	PL104-205C
Layout	ES205
Door Style	PL104
Sidelite	PL102
Profile	SS Sticking/C Panel
Wood Species	Plain Sawn White Oak
Finish	Grey Mist
Glass	Clear





MODERN FARMHOUSE

System Code	FL1001-108C
Layout	ES108
Door Style	FL1001
Sidelite	FL501
Transom	TRG400
Profile	BV Sticking/C Panel
Wood Species	Quarter Sawn White Oak
Finish	Grey Mist
Glass	Clear

MODERN FARMHOUSE

System Code	PL106-204A
Layout	ES204
Door Style	PL106
Transom	TRG100
Profile	SS Sticking/C Panel
Wood Species	Walnut
Finish	Amaretto
Glass	Clear



Choose One of Our **Featured Entry Systems**

Designed by TruStile and ready to order through your local dealer.

Or Customize Your Own Entry System

Follow these simple steps to design your own unique entry system.

Featured Modern Farmhouse Entry Systems in this Catalog

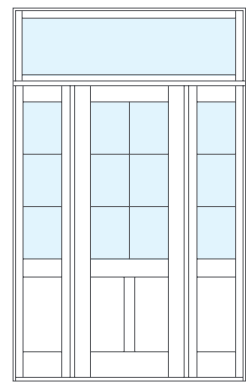

PL206-108C
pg 45

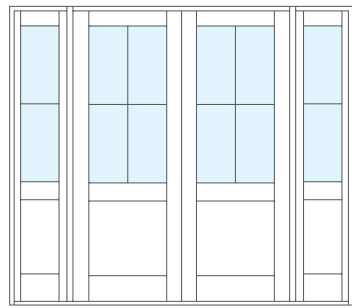

PL104-205C
pg 47

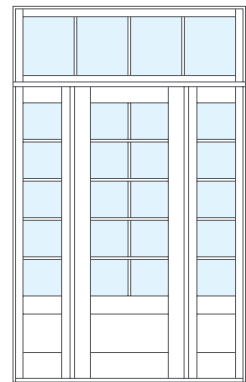

FL1001-108C
pg 49



PL106-204A
pg 51

Other Featured Modern Farmhouse Entry Systems

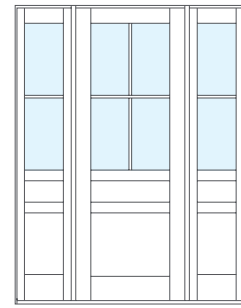

PL224-105C
online

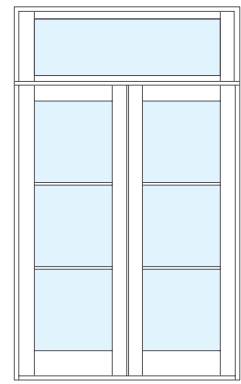

FL300-204A
online

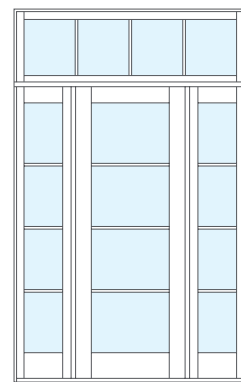

FL400-108C
online



PL119-106D
online

1 Choose Your Entry System Layout

See pages 104-105 for additional configurations

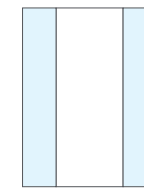

ES105

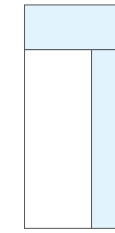

ES106

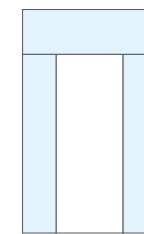

ES108

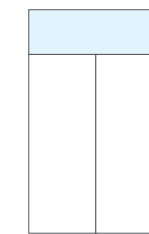

ES204

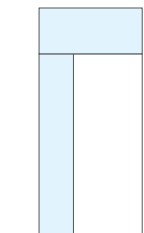

ES107

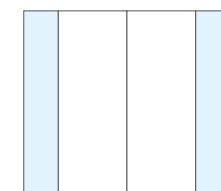

ES205

2 Select Your Door Style

PL Series (see pages 110-111)



PL104

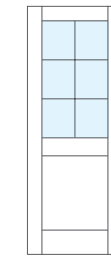

PL106

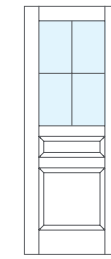

PL224

FL Series (see pages 108-109)

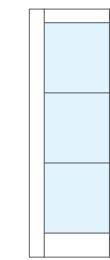

FL300

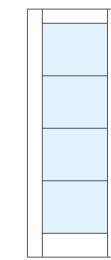

FL400

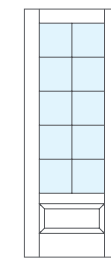

FL1001

3 Choose Your Sidelites and Transoms

FL Series

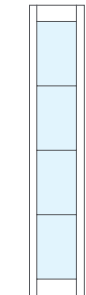

FL400

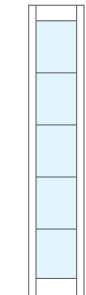

FL500

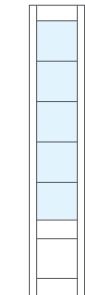

FL501

PL Series

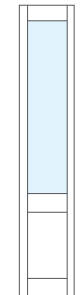

PL100

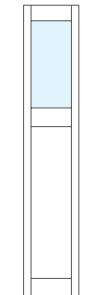

PL130

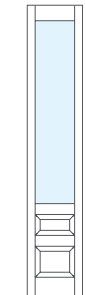

PL220

(see pages 114-115 for sidelite and transom details)

TRG Series



TRG100

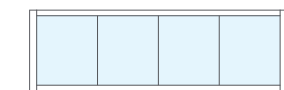

TRG400



FRENCH COUNTRY

ORNATE
CHARMING
ELEGANT

System Code	TS5030-108D
Layout	ES108
Door Style	TS5030
Sidelite	FL110
Transom	TRG100
Profile	BV Sticking/A Panel
Wood Species	Walnut
Finish	Clear
Glass	Clear



FRENCH COUNTRY

System Code	TS3160-201
Layout	ES201
Door Style	TS3160 (Common Arch Pair)
Profile	OG Sticking/B Panel
Wood Species	Paint-Grade Mahogany
Paint Color	SW 6227 Meditative



FRENCH COUNTRY

System Code	TS4200-105C
Layout	ES105
Door Style	TS4200
Sidelite	TS3130
Profile	OG Sticking/B Panel
Wood Species	Mahogany
Finish	Caramel
Glass	Clear

Modified lock rail height. Please see your local TruStile dealer for more details. Sidelite top panels substituted for glass.

FRENCH COUNTRY

System Code	TS5020-201
Layout	ES201
Door Style	TS5020 (Common Arch Pair)
Profile	OG Sticking/B Panel
Wood Species	Paint-Grade Mahogany
Color	SW 9580 Cracked Pepper
Glass	Beveled



Door top panels substituted for glass.

Choose One of Our **Featured Entry Systems**

Designed by TruStile and ready to order through your local dealer.

Or Customize Your Own Entry System

Follow these simple steps to design your own unique entry system.

Featured French Country Entry Systems in this Catalog

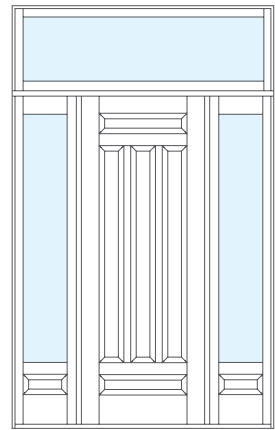

TS5030-108D
pg 55

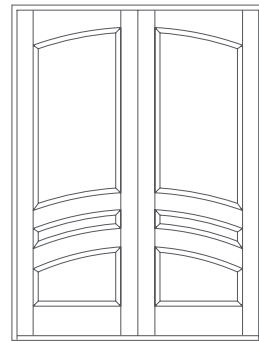

TS3160-201
pg 57

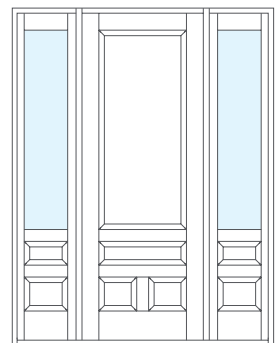

TS4200-105C
pg 59

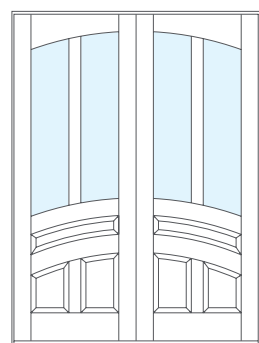

TS5020-201
pg 61

Other Featured French Country Entry Systems

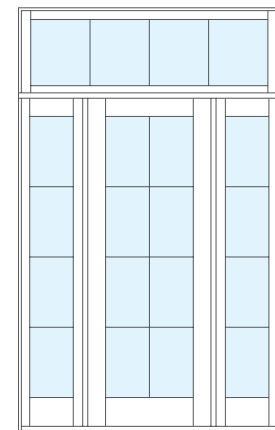

FL800-108C
online

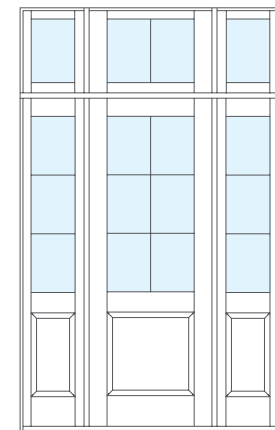

PL106-109C
online

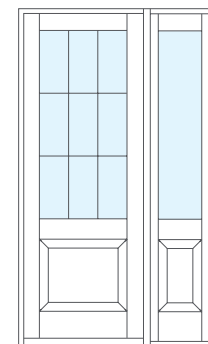

PL109-102C
online

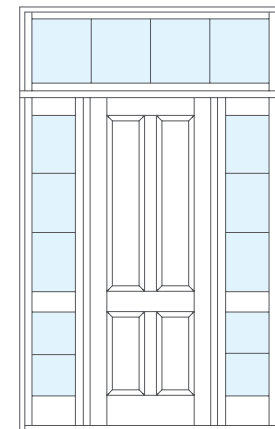

TS4000-108D
online

1 Choose Your Entry System Layout

See pages 104-105 for additional configurations

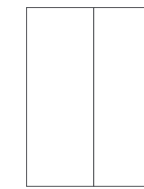

ES201

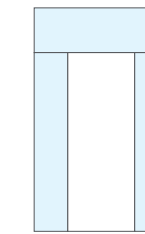

ES108

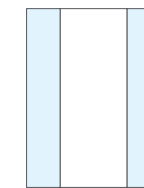

ES105

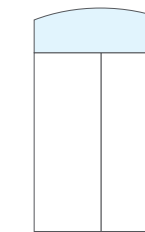

ES504

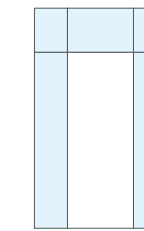

ES109

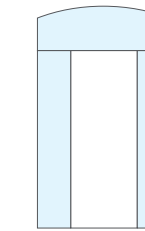

ES308

2 Select Your Door Style

TS Series (see pages 112-113)

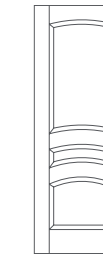

TS3160

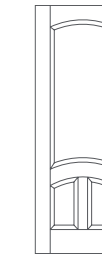

TS3040

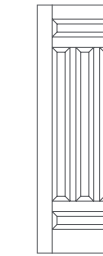

TS5030

FL Series (see pages 108-109)

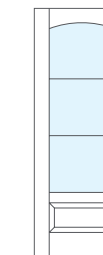

FL315

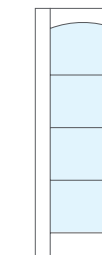

FL420

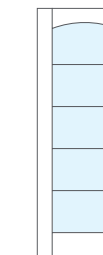

FL520

3 Choose Your Sidelites and Transoms

FL Series

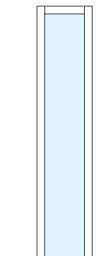

FL100

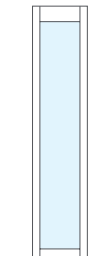

FL110

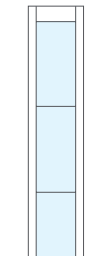

FL300

PL Series



PL100



PL220



PL103

(see pages 114-115 for sidelite and transom details)

TRG Series

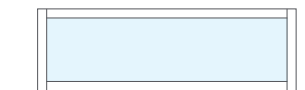

TRG100

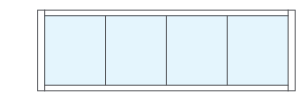

TRG400



COASTAL®

BREEZY
WELCOMING
CASUAL

System Code	FL810-105C
Layout	ES105
Door Style	FL810
Sidelite	FL401
Profile	OG Sticking/B Panel
Wood Species	Mahogany
Finish	White Haze
Glass	Clear

*Architectural Category Only. Impact and Hurricane ratings not currently available. See your TruStile dealer to verify compatibility with your local building code.



COASTAL*

System Code	TS3130-109C
Layout	ES109
Door Style	TS3130
Sidelite	TS3130
Transom	TRG100
Profile	SS Sticking/C Panel
Wood Species	Rift Sawn White Oak
Finish	Grey Mist
Glass	Clear

Door and sidelite top panels substituted for glass.

*Architectural Category Only. Impact and Hurricane ratings not currently available. See your TruStile dealer to verify compatibility with your local building code.



COASTAL*

System Code	TMP1000-107B
Layout	ES107
Door Style	TMP1000
Sidelite	DSG100
Transom	DSG100
Profile	1/4" Kerf Cut Reveal
Wood Species	Rift Sawn White Oak
Finish	White Haze
Glass	Clear



COASTAL*

System Code	PL145-105C
Layout	ES105
Door Style	PL145
Sidelite	PL145
Profile	SS Sticking/V-Groove Panel
Wood Species	Walnut
Finish	Slate
Glass	Clear

*Architectural Category Only. Impact and Hurricane ratings not currently available. See your TruStile dealer to verify compatibility with your local building code.

Choose One of Our **Featured Entry Systems**

Designed by TruStile and ready to order through your local dealer.

Or Customize Your Own Entry System

Follow these simple steps to design your own unique entry system.

Featured Coastal Entry Systems in this Catalog

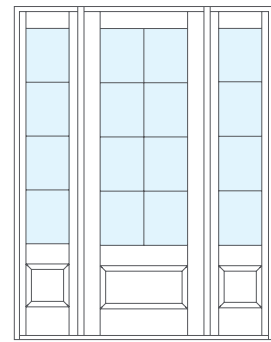

FL810-105C
pg 65

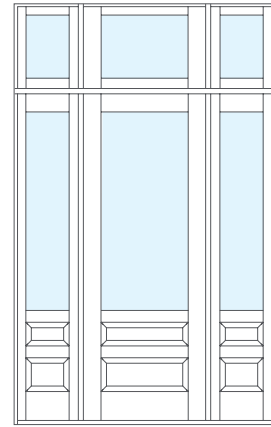

TS3130-109C
pg 67

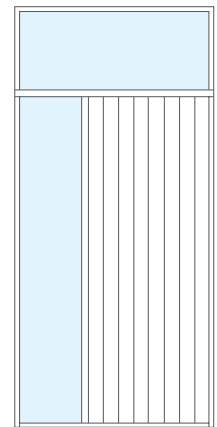

TMP1000-107B
pg 69

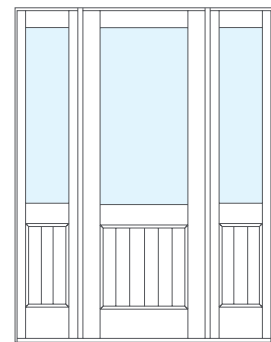

PL145-105C
pg 71

Other Featured Coastal Entry Systems

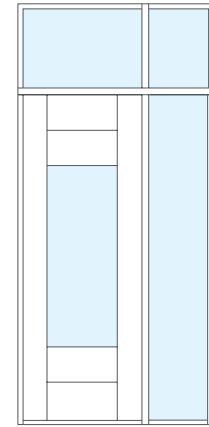

TM9250-115B
online

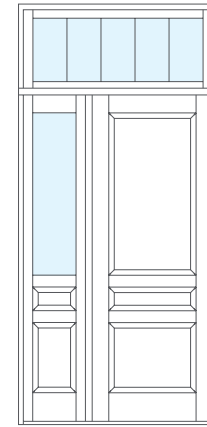

TS3070-106D
online

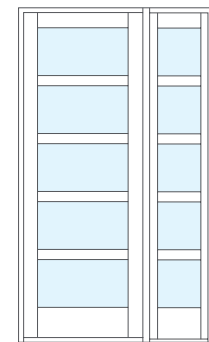

TS5000-102C
online

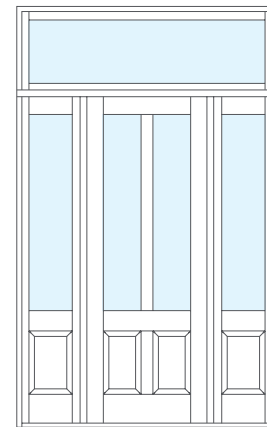

TS4140-108C
online

1 Choose Your Entry System Layout

See pages 104-105 for additional configurations

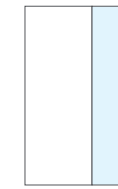

ES102



ES105

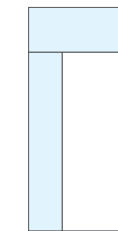

ES107



ES109

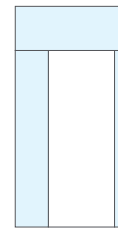

ES108

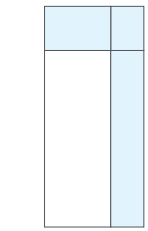

ES115

2 Select Your Door Style

TS Series (see pages 112-113)



TS3130

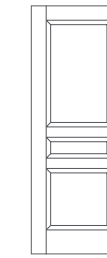

TS3070

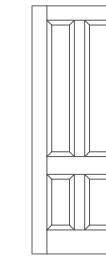

TS4140

FL Series (see pages 108-109)

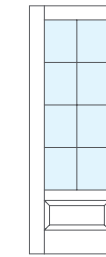

FL810

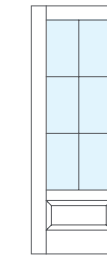

FL616

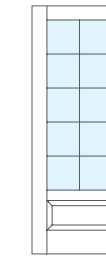

FL1001

PL Series (see pages 110-111)

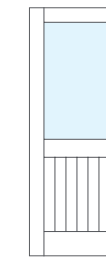

PL145

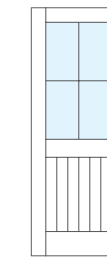

PL154

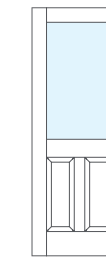

PL220

3 Choose Your Sidelites and Transoms

FL Series

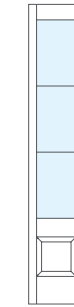

FL310



FL100



FL110

PL Series



PL145



PL220



PL100

(see pages 114-115 for sidelite and transom details)

TRG Series



TRG100

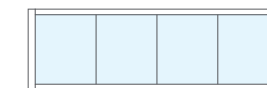

TRG400

*Architectural Category Only. Impact and Hurricane ratings not currently available. See your TruStile dealer to verify compatibility with your local building code.



MEDITERRANEAN

WARM
VIBRANT
GRAND

System Code	PL145-201
Layout	ES201
Door Style	PL145
Profile	QB Sticking/V-Groove Panel
Wood Species	Walnut
Finish	Clear
Glass	Clear

MEDITERRANEAN

System Code	TS3130-201
Layout	ES201
Door Style	TS3130
Profile	BM Sticking/B Panel
Wood Species	Walnut
Finish	Slate





MEDITERRANEAN

System Code	VG3000-105C
Layout	ES105
Door Style	VG3000
Sidelite	TS3000
Profile	SS Sticking/V-Groove Panel
Wood Species	Walnut
Finish	Clear
Glass	Clear



MEDITERRANEAN

System Code	VG1000-401
Layout	ES401
Door Style	VG1000 with Radius Top
Profile	Standard V-Groove
Wood Species	Mahogany
Finish	Ebony

Choose One of Our **Featured Entry Systems**

Designed by TruStile and ready to order through your local dealer.

Or Customize Your Own Entry System

Follow these simple steps to design your own unique entry system.

Featured Mediterranean Entry Systems in this Catalog

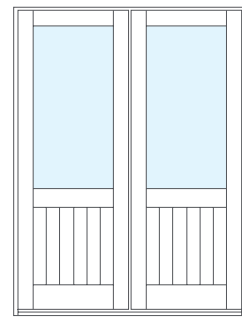

PL145-201
pg 75

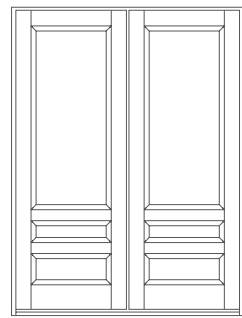

TS3130-201
pg 77

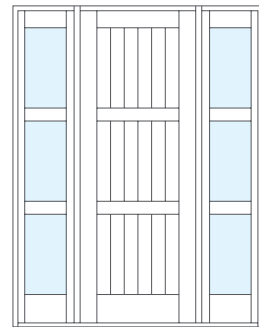

VG3000-105C
pg 79

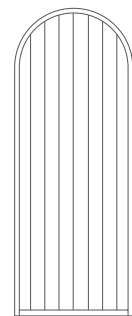

VG1000-401
pg 81

Other Featured Mediterranean Entry Systems

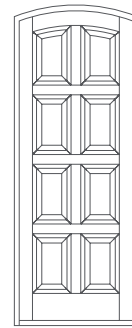

TS8020-301
online

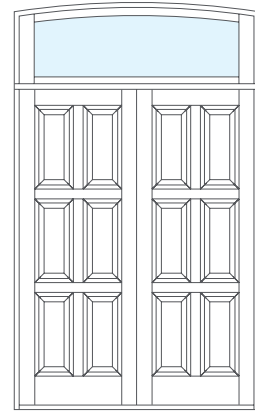

TS6080-504A
online

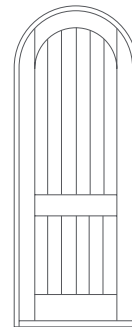

VG2070-401
online

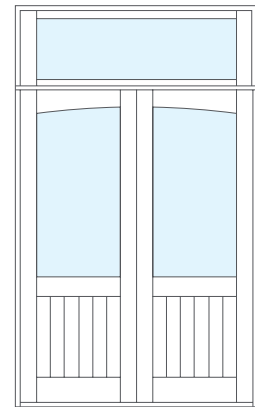

PL176-204A
online

1 Choose Your Entry System Layout

See pages 104-105 for additional configurations

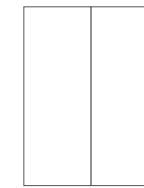

ES201



ES308



ES401

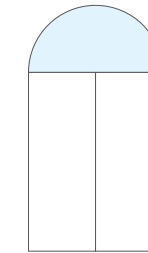

ES604



ES301

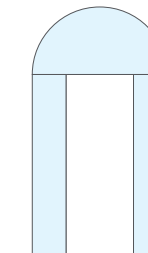

ES408

2 Select Your Door Style

VG Series (see page 113)

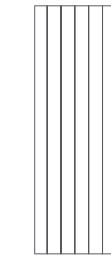

VG1000



VG2070



VG3020

TS Series (see pages 112-113)

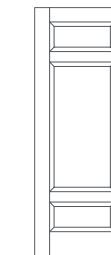

TS3080

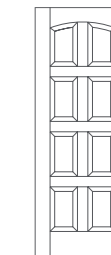

TS8020

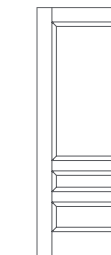

TS3130

PL Series (see pages 110-111)

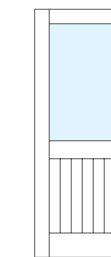

PL145

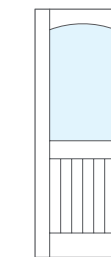

PL146

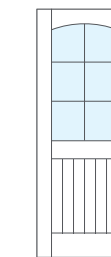

PL176

3 Choose Your Sidelites and Transoms

PL Series

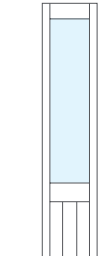

PL145

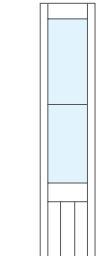

PL152

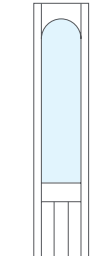

PL190

FL Series

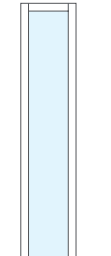

FL100

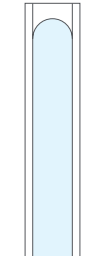

FL103

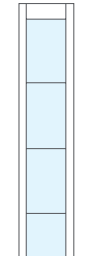

FL400

(see pages 114-115 for sidelite and transom details)

TRG Series

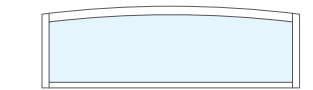

TRG110

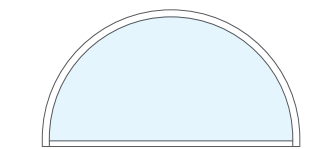

TRG120



CRAFTSMAN

AUTHENTIC
PRECISE
COMFORTING

System Code	PL333-105C
Layout	ES105
Door Style	PL333 (Small Dentil Bird Ledge)
Sidelite	PL130 (Small Dentil Bird Ledge)
Profile	SS Sticking/C Panel
Wood Species	Plain Sawn White Oak
Finish	Grey Mist
Glass	Clear

CRAFTSMAN

System Code	FL618-205C
Layout	ES215
Door Style	FL618 (Common Arch Pair)
Sidelite	FL315 (Common Arch Pair)
Profile	QR Sticking/B Panel
Wood Species	Mahogany
Finish	White Haze
Glass	Clear





CRAFTSMAN

System Code	PL236-109C
Layout	ES109
Door Style	PL236
Sidelite	PL104
Transom	TRG200 and TRG300
Profile	SS Sticking/C Panel
Wood Species	Paint-Grade Mahogany
Paint Color	SW 7006 Extra White
Glass	Clear

CRAFTSMAN

System Code	PL243-105C
Layout	ES105
Door Style	PL243 (Small Dentil Bird Ledge)
Sidelite	PL232 (Small Dentil Bird Ledge)
Profile	SS Sticking/C Panel
Wood Species	Rift Sawn White Oak
Finish	Hazelnut
Glass	Clear



Choose One of Our **Featured Entry Systems**

Designed by TruStile and ready to order through your local dealer.

Or Customize Your Own Entry System

Follow these simple steps to design your own unique entry system.

Featured Craftsman Entry Systems in this Catalog

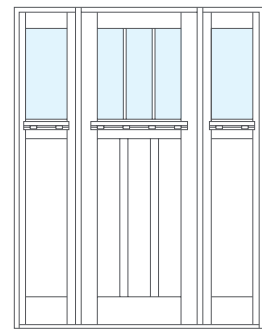

PL333-105C
pg 85

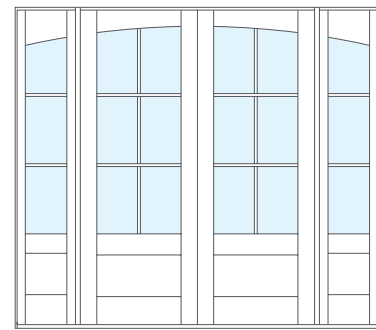

FL618-205C
pg 87

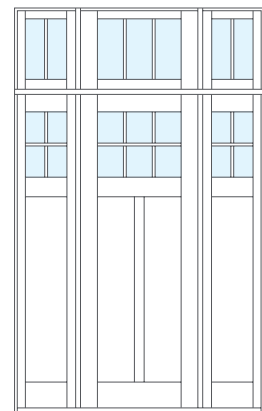

PL236-109C
pg 89

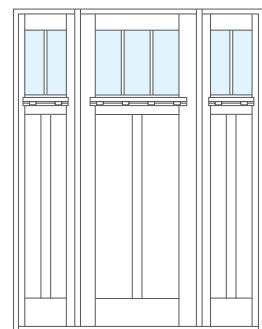

PL243-105C
pg 91

Other Craftsman Entry Systems

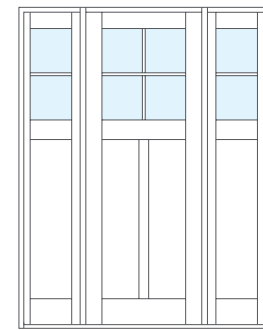

PL234-105C
online

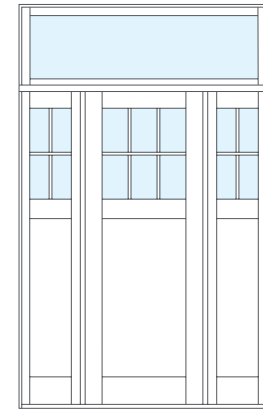

PL136-108C
online

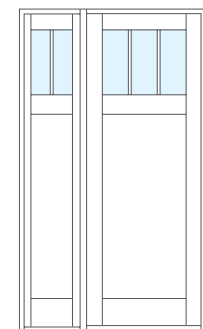

PL143-103C
online

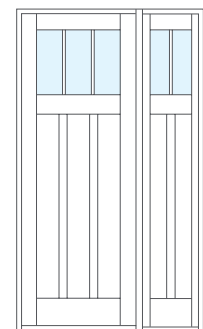

PL343-102C
online

1 Choose Your Entry System Layout

See pages 104-105 for additional configurations

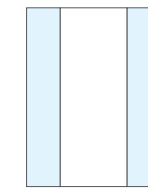

ES105

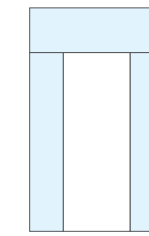

ES108

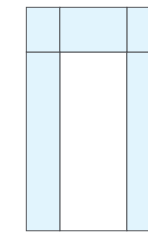

ES109

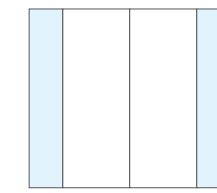

ES205

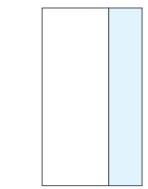

ES102

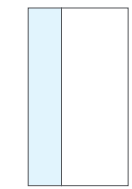

ES103

2 Select Your Door Style

FL Series (see pages 108-109)

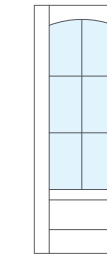

FL618



FL300

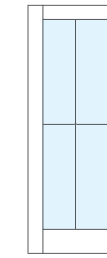

FL450

PL Series (see pages 110-111)

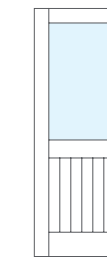

PL145



PL100

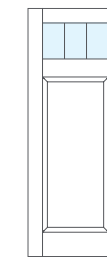

PL143

3 Choose Your Sidelites and Transoms

FL Series

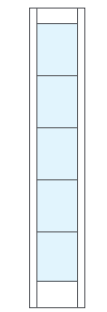

FL400

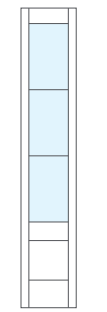

FL310

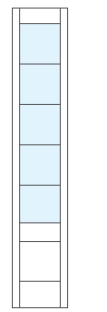

FL501

PL Series

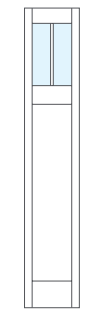

PL132

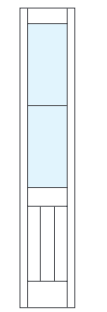

PL152

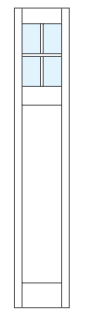

PL134

(see pages 114-115 for sidelite and transom details)

TRG Series

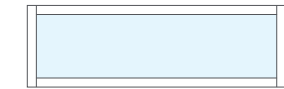

TRG100

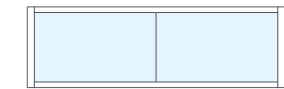

TRG200



CAPE COD

HISTORIC
AMBITIOUS
STATELY

System Code	PL224-109C
Layout	ES109
Door Style	PL224
Sidelite	PL222
Transom	TRG100
Profile	OG Sticking/A Panel
Wood Species	Rift Sawn White Oak
Finish	Ebony
Glass	Clear

CAPE COD

System Code	PL106-308C
Layout	ES308
Door Style	PL106
Sidelite	PL103
Transom	TRG110
Profile	QR Sticking/A Panel
Wood Species	Plain Sawn White Oak
Finish	Hazelnut
Glass	Clear





CAPE COD

System Code	TS2210-105C
Layout	ES105
Door Style	TS2210
Sidelite	TS2210
Profile	CB Sticking/B Panel
Wood Species	Walnut
Finish	Champagne
Glass	Clear

CAPE COD

System Code	TS4140-105C
Layout	ES105
Door Style	TS4140
Sidelite	PL100
Profile	QB Sticking/C Panel
Wood Species	Rift Sawn White Oak
Finish	Ebony
Glass	Clear



Choose One of Our **Featured Entry Systems**

Designed by TruStile and ready to order through your local dealer.

Or Customize Your Own Entry System

Follow these simple steps to design your own unique entry system.

Featured Cape Cod Entry Systems in this Catalog



PL224-109C
pg 95

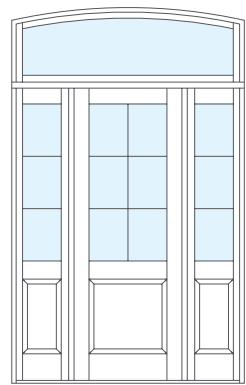

PL106-308C
pg 97

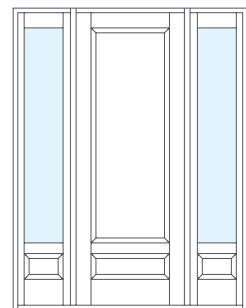

TS2210-105C
pg 99

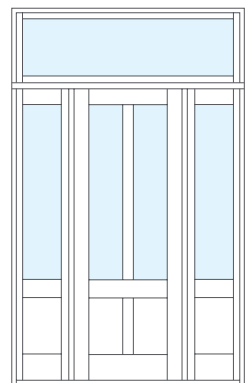

TS4140-105C
pg 101

Other Cape Cod Entry Systems

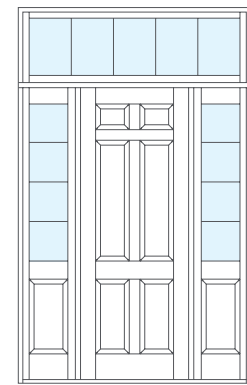

TS6000-108D
online

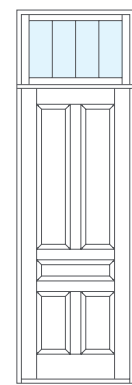

TS5060-104D
online

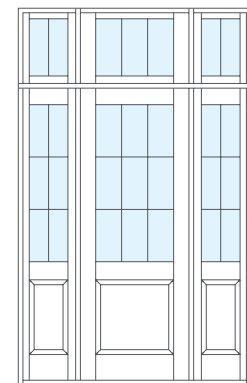

PL109-109C
online

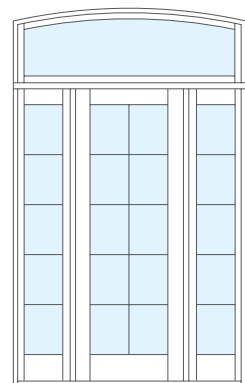

FL1000-108C
online

1 Choose Your Entry System Layout

See pages 104-105 for additional configurations



ES104



ES105

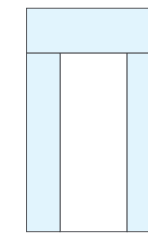

ES108

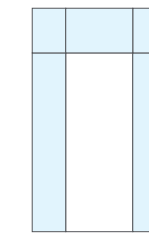

ES109

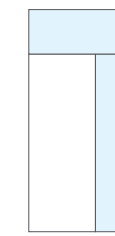

ES106

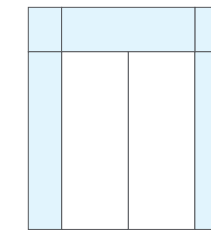

ES209

2 Select Your Door Style

TS Series (see pages 112-113)

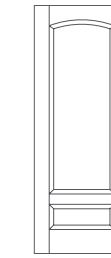

TS2230

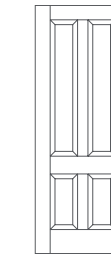

TS4140

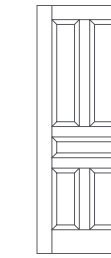

TS5060

FL Series (see pages 108-109)

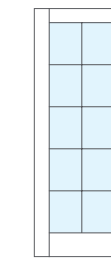

FL1000

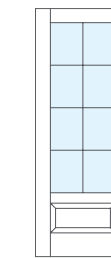

FL1001

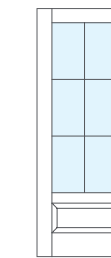

FL616

PL Series (see pages 110-111)



PL106



PL109



PL224

3 Choose Your Sidelites and Transoms

FL Series

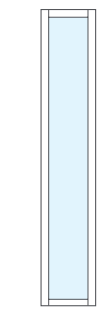

FL100



FL500

PL Series

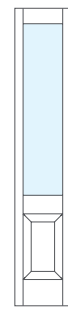

PL100

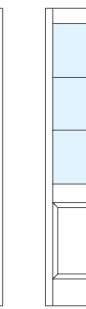

PL103

(see pages 114-115 for sidelite and transom details)

TRG Series



TRG100

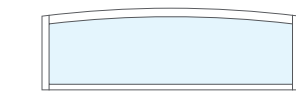

ATR100

Entry Systems Layouts

Begin every project by selecting your entry system layout. From a single door, or a door and one sidelite, to a pair of doors with matching sidelites and transoms, this key will get you off to the right start.

SINGLE DOOR SYSTEMS

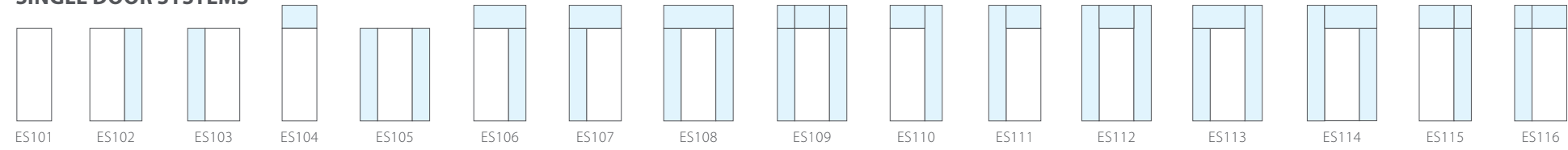

PAIRED DOOR SYSTEMS

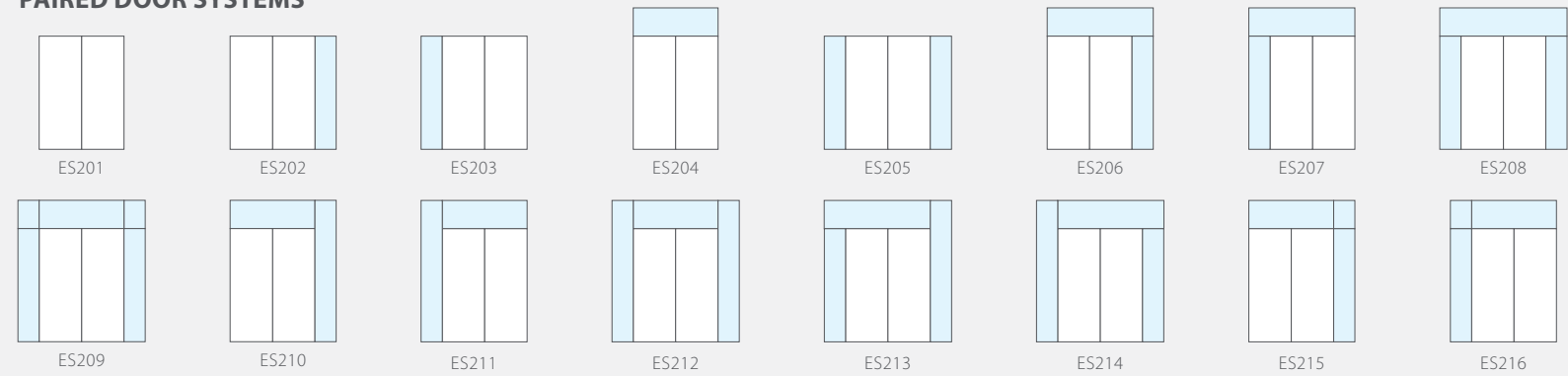

ARCH- AND RADIUS-TOP SYSTEMS



*Widths limited to 96"



TMIR6001 with DSG100 Sidelite.
See pg 9 for complete specs.



TM SERIES



TM SERIES

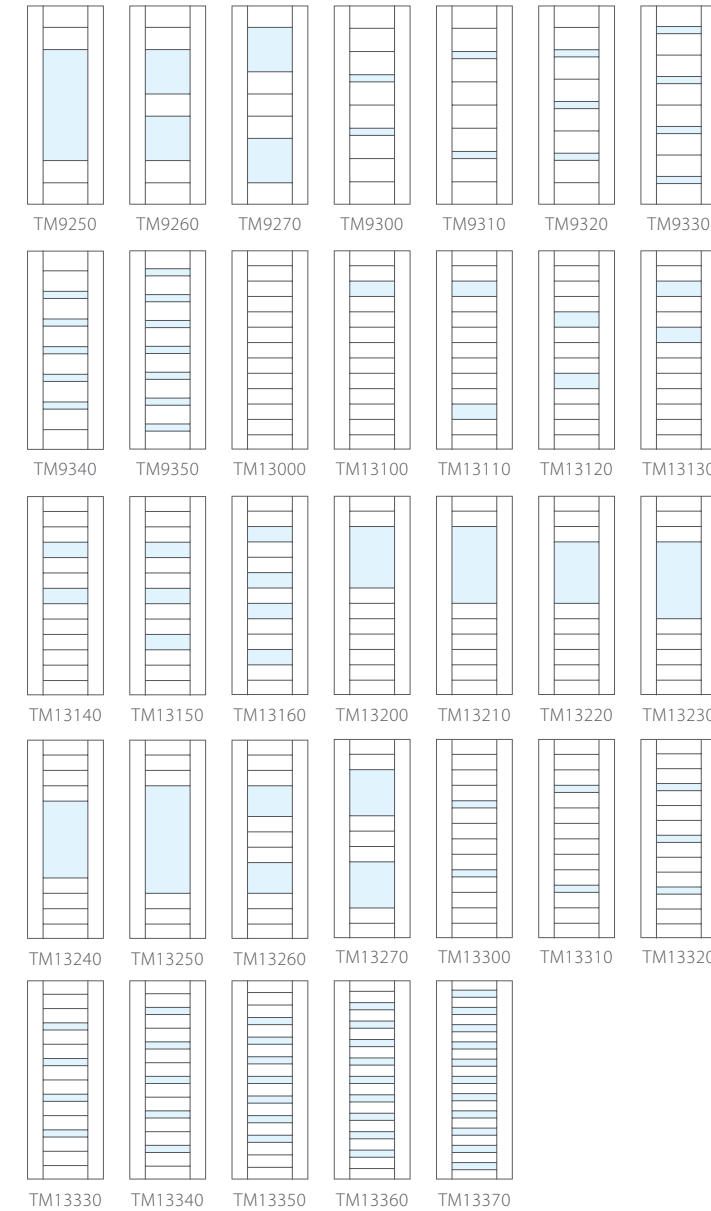

TMF SERIES

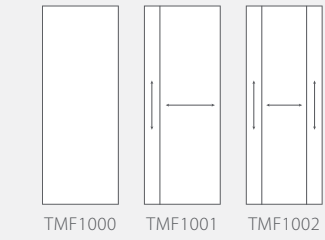

Arrows indicate grain direction.

TMP SERIES

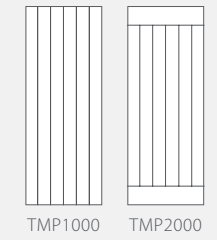

TMIR SERIES

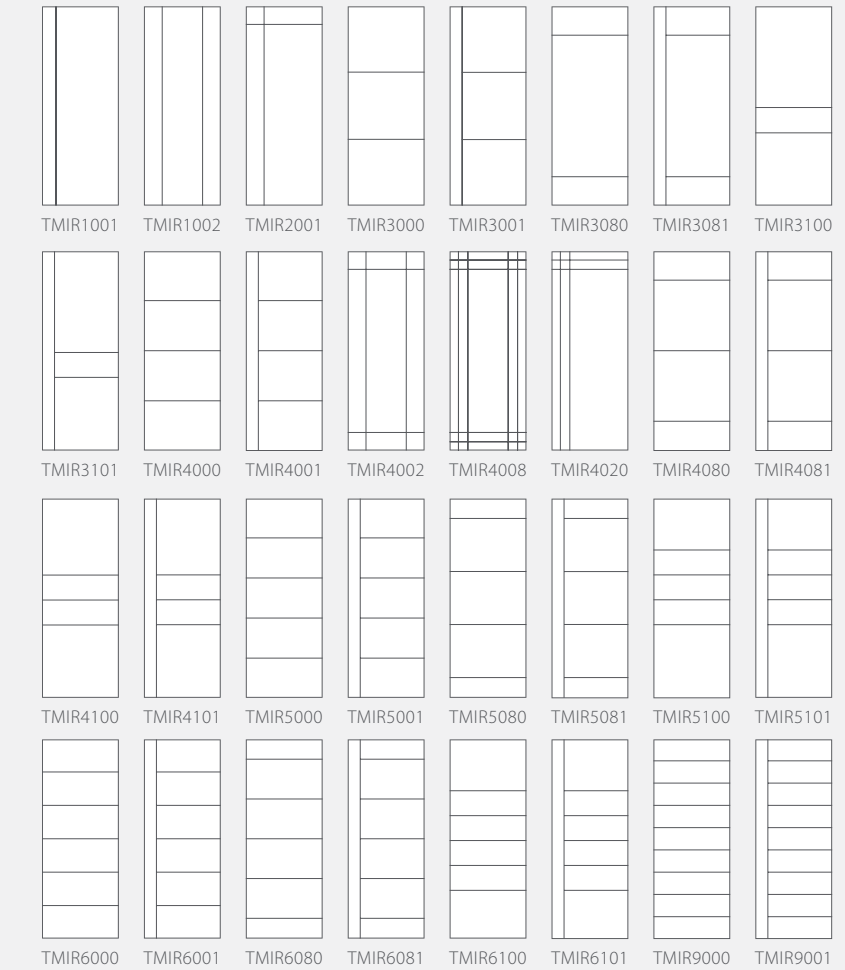



FL1001 with FL501 Sidelites and TRG400 Transom.
See page 49 for complete specs.

FL SERIES

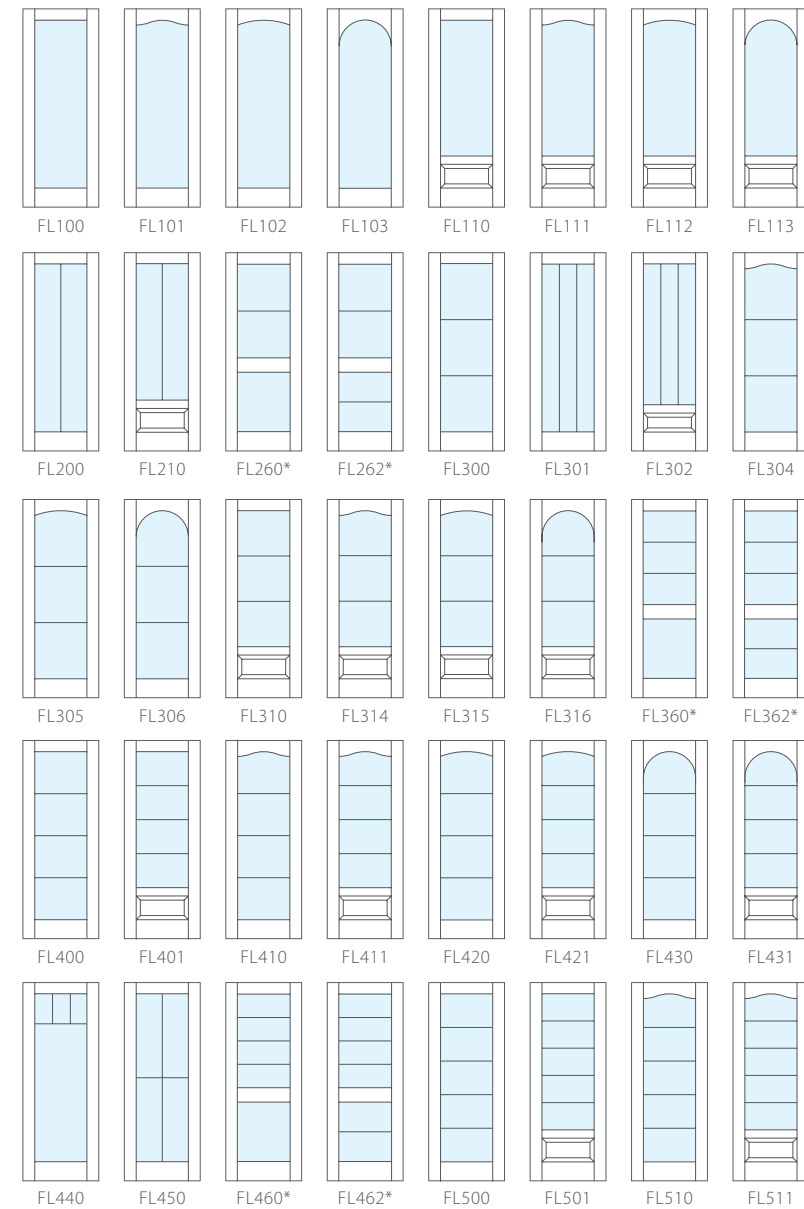

FL SERIES

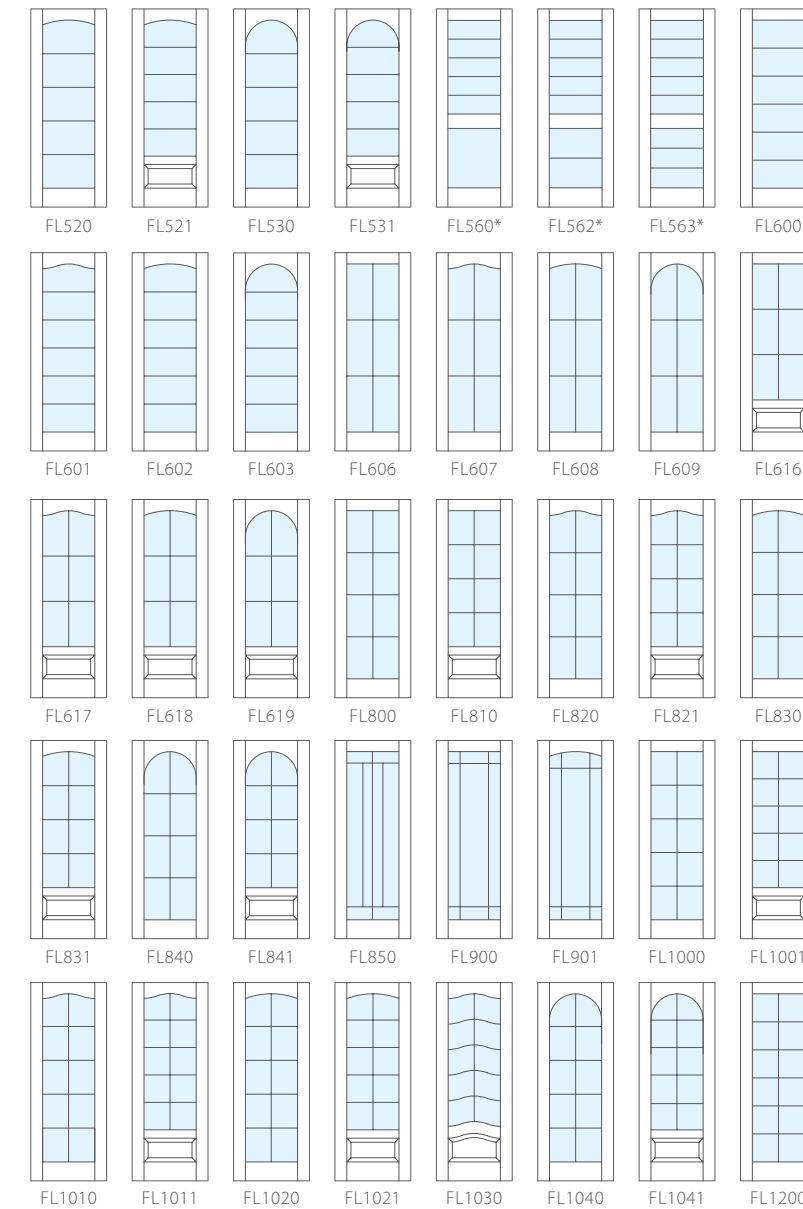

FL SERIES



*These styles available only as sidelites.

PL SERIES



PL SERIES



PL SERIES

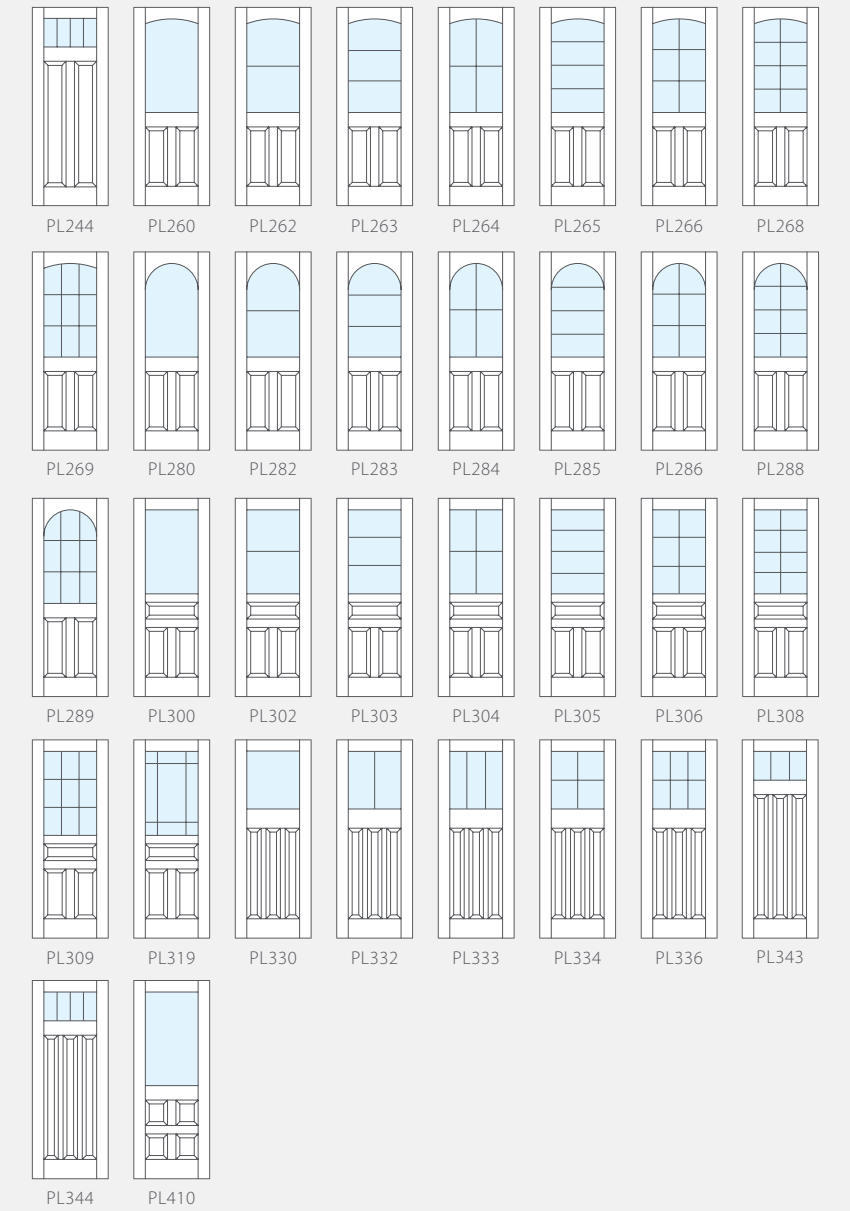

TS SERIES

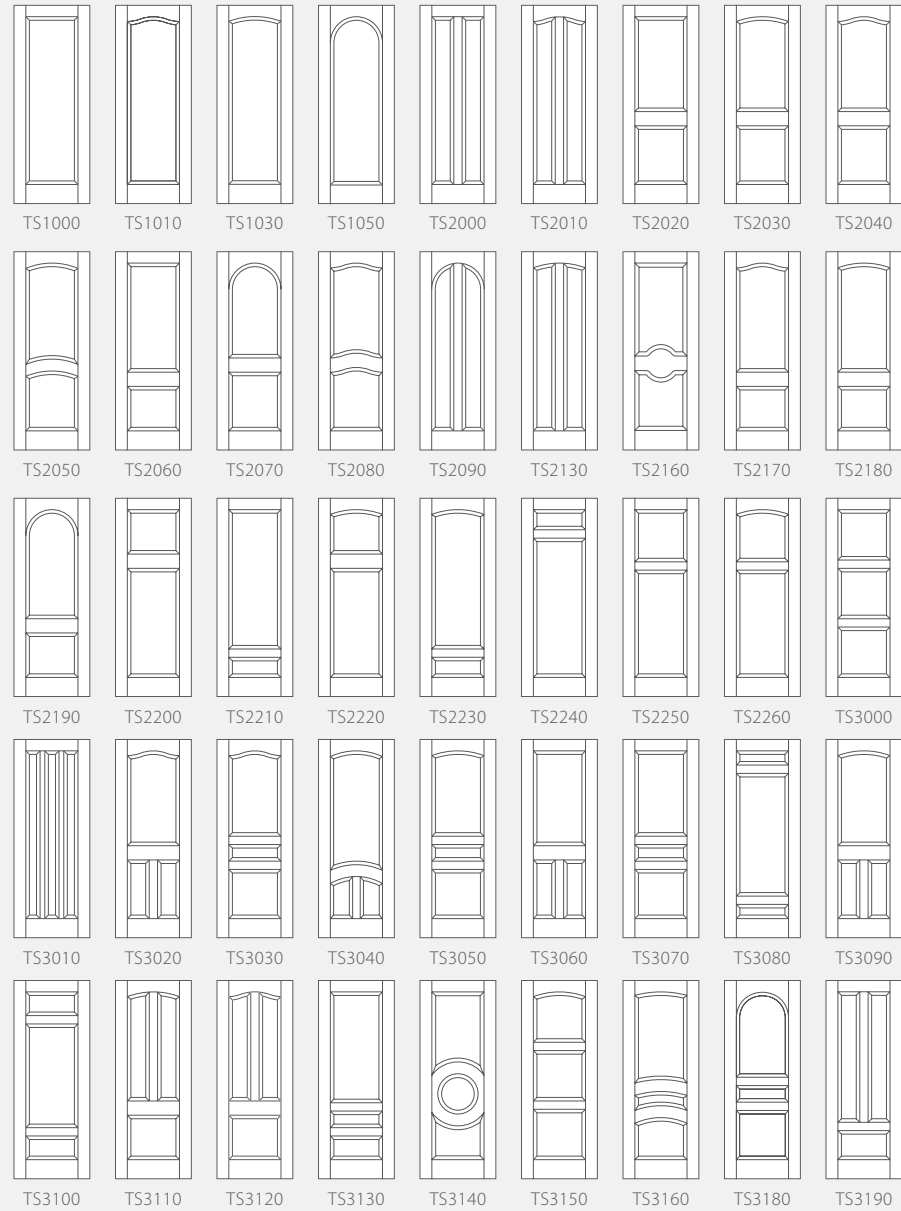

TS SERIES



TS5020 Common Arch Pair with substituted glass panels.
 See page 60 for complete specs.

TS SERIES

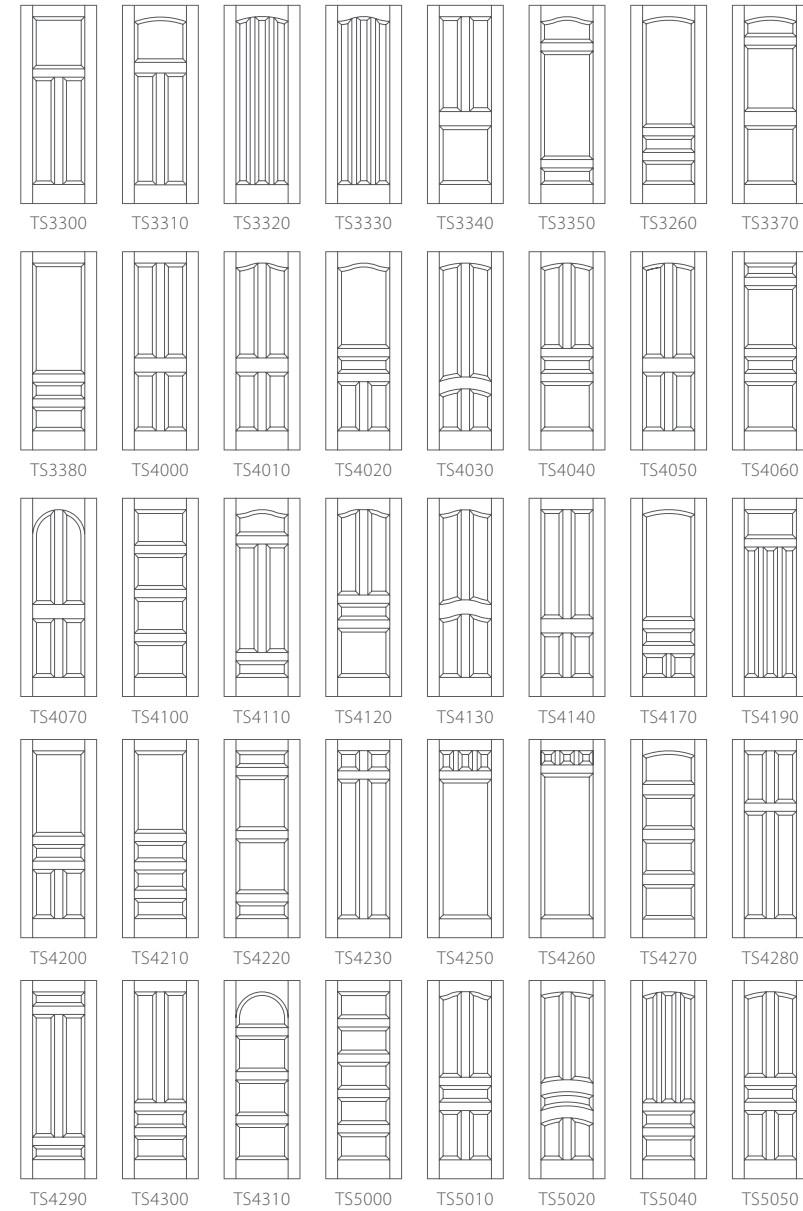

NOTE: Panels can be replaced for glass in most TS Series Doors.

TS SERIES

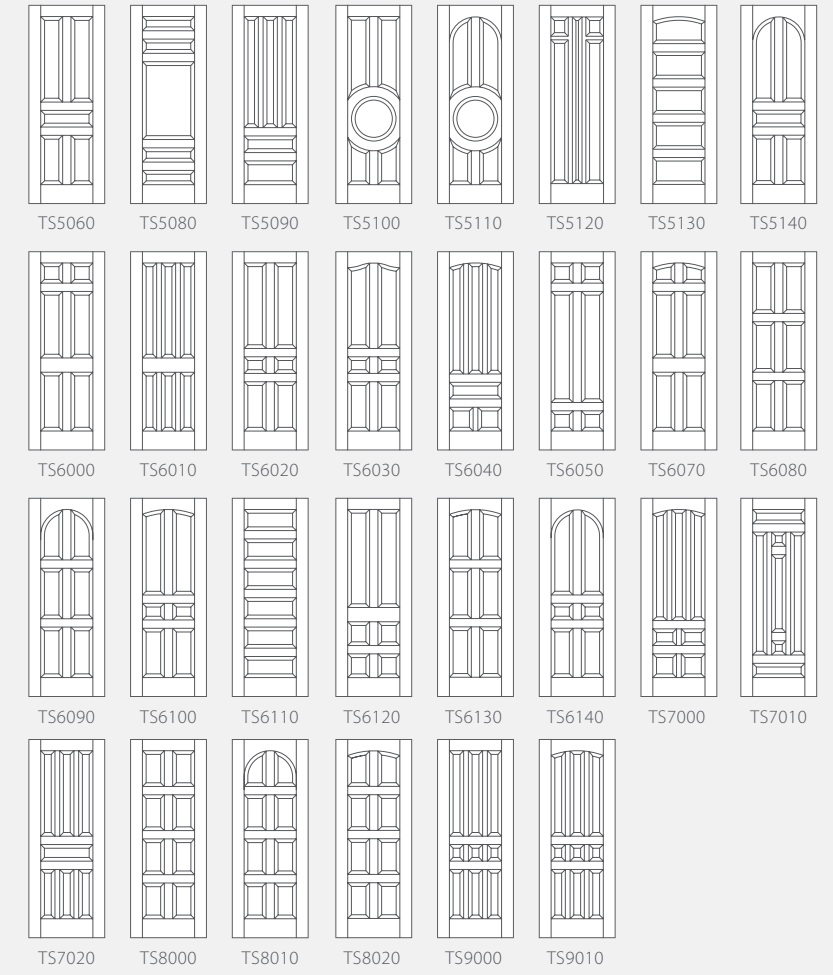

VG SERIES

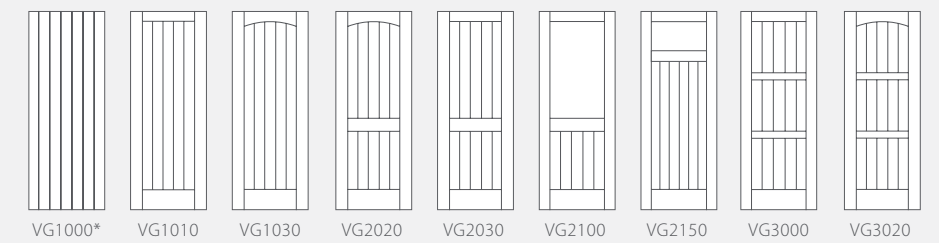

*Available with arch- or radius-top.

Transoms

Select from this extensive collection of transoms to complement your entry door.



IN-SASH SQUARE TRANSOMS

Available in 1- to 18-lites.

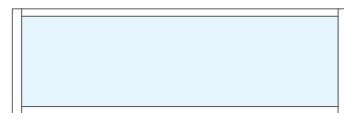

TRG100

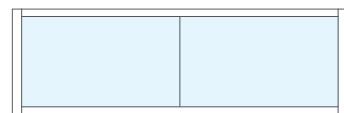

TRG200

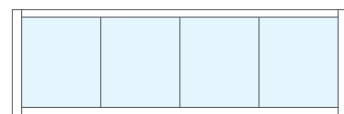

TRG400



ARCH- AND RADIUS-TOP TRANSOMS

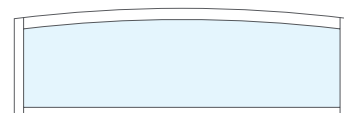

TRG110

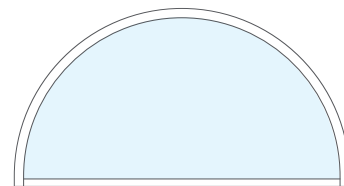

TRG120



DIRECT SET SIDELITES AND TRANSOMS

Maximize the amount of natural light available.

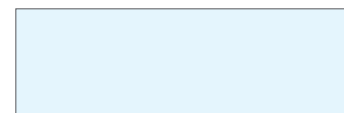

DSG100

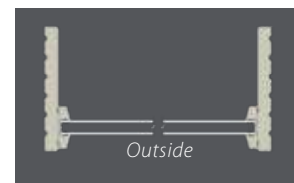

Direct Set Cross Section

Sidelites

Select from this extensive collection of sidelites to complement your entry door. Many panel doors available with glass options.



ONE-LITE IN-SASH SIDELITES

A one-lite in-sash sidelite is a classic look that brings natural light into your entrance.

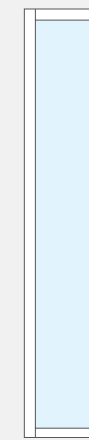

FL100

Order sidelites with stiles and rails as narrow as 1-7/8".



COMPLEMENTARY SIDELITES

We offer a wide selection of sidelites to complement your door style.



PL134

FL315

PL102

FL400



MATCHING DOOR SIDELITES

Many door styles are available as a matching sidelite.

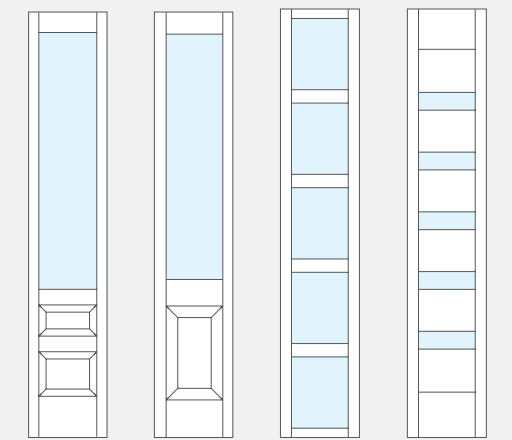

TS3130

PL100

TS5000

TM9310

Note: Most door styles on pages 106-113 can be selected as a sidelite.

Panel Profiles



Raised (A) Panel



Scoop (B) Panel*



Flat (C) Panel



Double Hip (D) Panel



Senior Raised (E) Panel



Senior Bevel (F) Panel

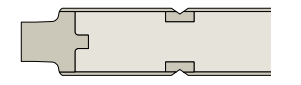

VG Panel

Sticking Profiles



Square Stick (SS) Sticking



Roman Ogee (OG) Sticking



One Step (OS) Sticking

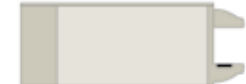

Quarter Bead (QB) Sticking



Quarter Round (QR) Sticking



Bevel (BV) Sticking

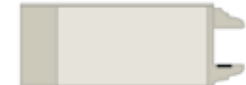

Cove & Bead (CB) Sticking

Applied Mouldings



Cove (CV) Applied Moulding



Low Profile Bolection (LP) Moulding



Bolection (BM) Moulding



Big Bolection (BB) Moulding

Simulated Divided Lite Bars (SDL)

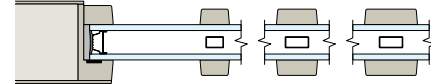

Square Stick (SS) SDL Glass

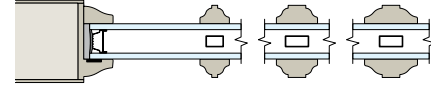

Roman Ogee (OG) SDL Glass

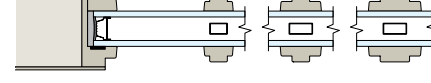

One Step (OS) SDL Glass

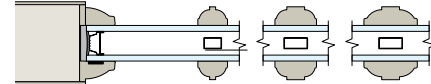

Quarter Bead (QB) SDL Glass

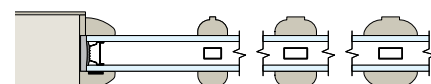

Quarter Round (QR) SDL Glass

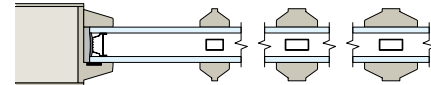

Bevel (BV) SDL Glass

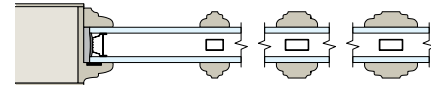

Cove & Bead (CB) SDL Glass

True Divided Lite Bars (TDL)

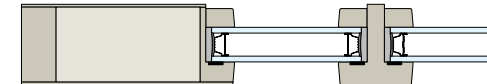

Square Stick (SS) ADL Glass

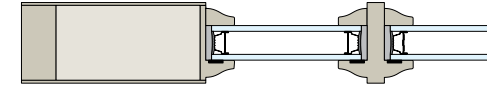

Roman Ogee (OG) ADL Glass

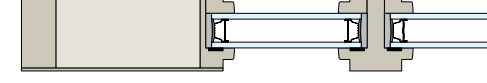

One Step (OS) ADL Glass

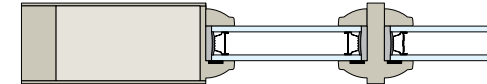

Quarter Bead (QB) ADL Glass

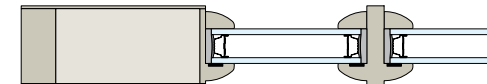

Quarter Round (QR) ADL Glass

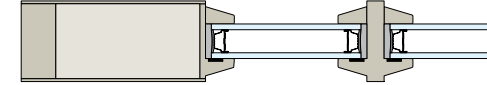

Bevel (BV) ADL Glass

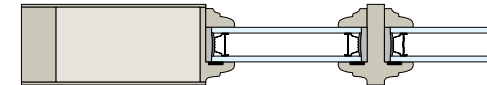

Cove & Bead (CB) ADL Glass

Profile Options and Construction

Years of testing through our partnership with Marvin has resulted in an entry system product engineered to last. We utilize cutting edge materials like Tricoya® MDF which is the most stable exterior MDF available today.

Exterior Wood Doors with Rim-Raised Panel

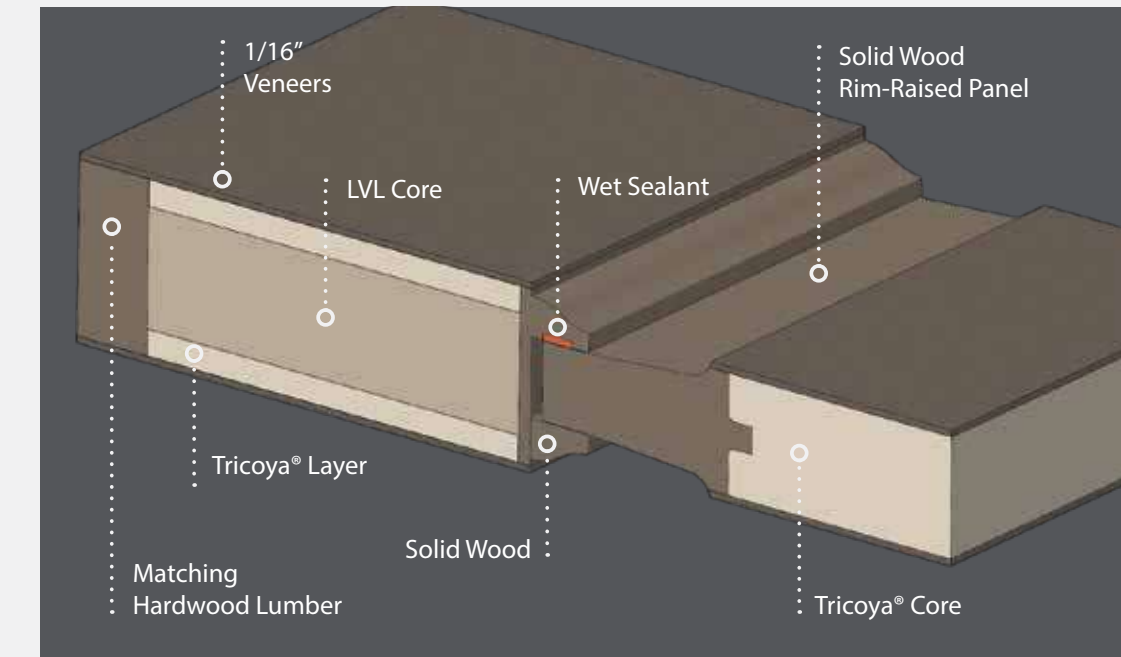

Tricoya® is a high-performance MDF panel product. It demonstrates outstanding durability and dimensional stability in the most extreme and challenging environments, including exterior, interior, wet, and high moisture applications. The product uses proprietary acetylated wood technology and a modified MDF manufacturing process to create a wood panel product with outstanding durability and stability.

Stain Options

Choose a premium hand-wiped finish to accentuate the natural beauty of our wood doors.

	Amaretto	Bleached	Cameo	Cappuccino	Caramel	Champagne	Cinnamon	Ebony	Espresso	Grey Mist	Hazelnut	Honey	Nutmeg	Slate	White Haze
MAHOGANY															
CHERRY															
CLEAR PINE															
DOUGLAS FIR															
SELECT ALDER															
WALNUT															
WHITE OAK															

For White Oak: Choose rift sawn, plain sawn or quarter sawn.
Plain sawn White Oak shown.

The color of the finish can vary depending on the color of the wood, lighting on the job site, and natural exposure to oxidation and sunlight. To get the best example of the stain color on a specific species, please visit your TruStile dealer.

Species Options

Choose from one of the many exterior-grade wood species.



Mahogany

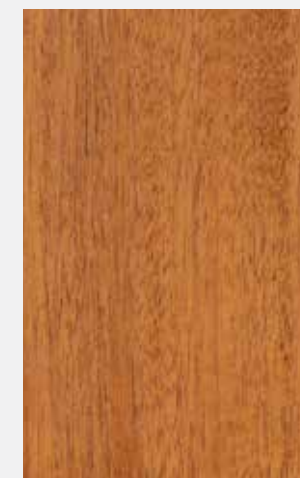

Genuine Mahogany

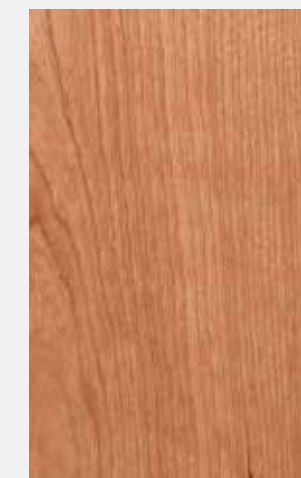

Cherry



Douglas Fir (Vertical Grain)



Select Alder



Walnut

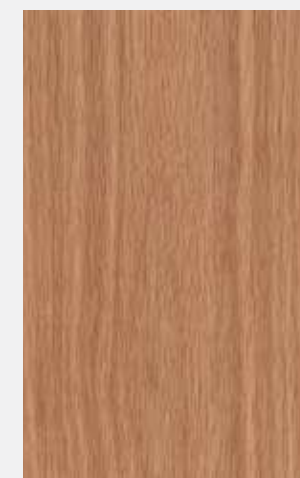

Plain Sawn White Oak



Quarter Sawn White Oak

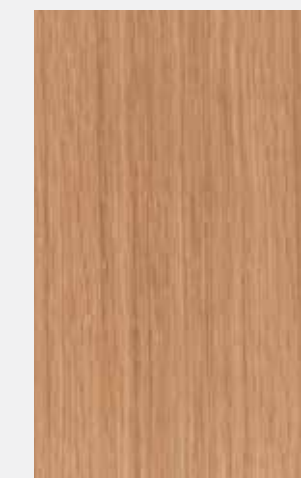

Rift Sawn White Oak



Clear Pine

Paint-Grade Mahogany and Paint-Grade Douglas Fir not shown.

Hinge Options

Choose from ten standard hinge finishes or select an option from Emtek or Baldwin.



US3 Bright Brass



US1D Black



US5 Antique Brass



US4 Satin Brass



US10A Antique Bronze



US14 Polished Nickel



US15 Satin Nickel



US15A Antique Nickel



US26 Polished Chrome



US26D Satin Chrome

Sill Options

Choose from one of five standard sill options to complete your entry system.



Oak Adjustable



Solid Wood



Solid Wood with
Brass Interlock



Hydrosill



ADA

Solid Wood Sills available in Genuine Mahogany and Plain Sawn White Oak.

Insulated Glass Options

Complete your grand entrance with one of our many insulated glass options, including LoE and several decorative patterns.



Clear (LoE 272)*



Frosted

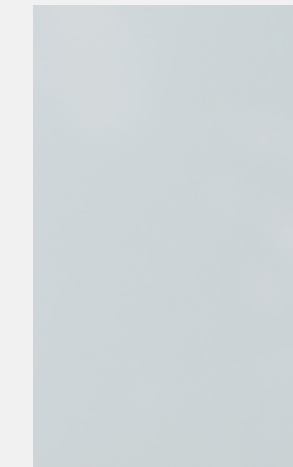

White Lami



Aqualite



Bevel



Glue Chip



Obscure



Rain



Reeded



Wavy Seedy

**Clear glass also available as LoE 366, LoE 340, LoE 180, Low Iron and Clear Lami.*

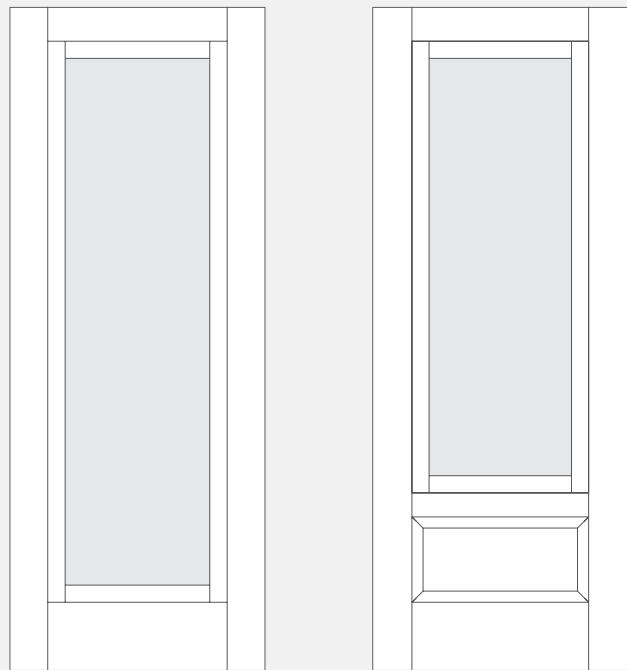

FL100

FL110

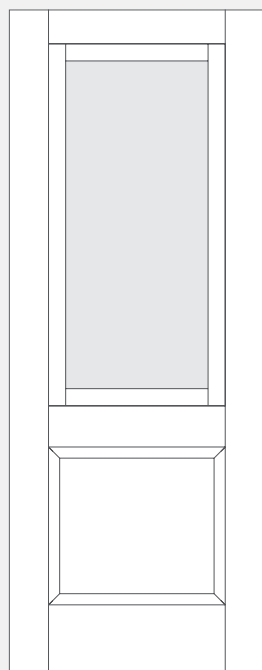

PL100

Wood Screen Door Styles

Select a complementary screen door for an added design touch.

FEATURES:

Available in 1-3/8" thickness only.

Available in all exterior species options and all standard panel and sticking options.

Comes standard with removable screen/storm insert.

OPTIONS:

Black hydraulic closer.

Screen door handlesets from Deltana and Emtek®

SCREEN CHOICES:

FIBERGLASS	ALUMINUM
Charcoal	Black
Hi-Vis-Black	Charcoal
POLYESTER	Bright Bronze
Pet	Bright Aluminum

Frame Profile and Mull Construction

All frame parts and wood sills undergo a wood dip treatment to protect against fungus and insects.

FRAME OPTIONS

UNIFRAME MULL POST OPTIONS

Single Rabbet Frame with Back-to-Back Mull Posts
Default for all door applications

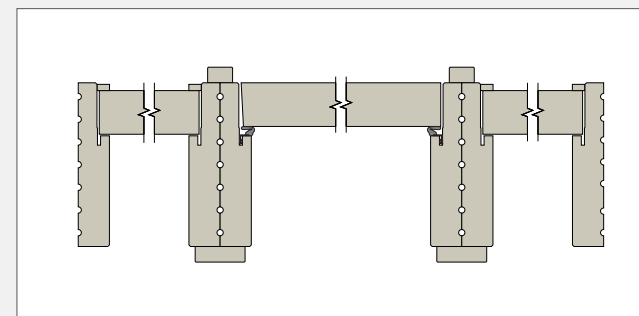

Single Rabbet Frame with 4-9/16" Uniframe Mull Posts

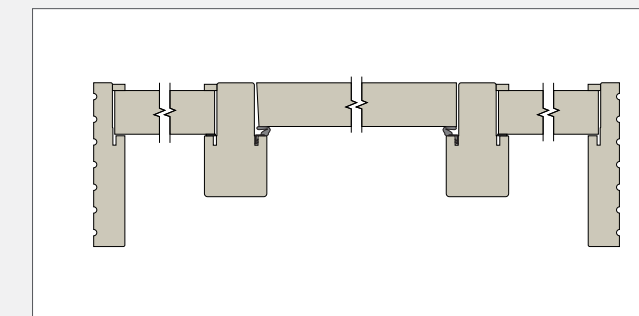

Double Rabbet Frame with Back-to-Back Mull Posts
Accommodates screen door applications

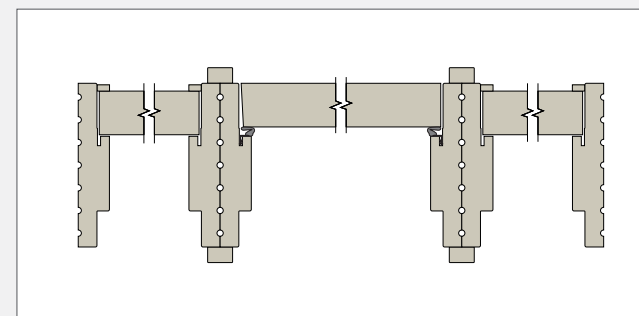

Single Rabbet Frame with 6-9/16" Uniframe Mull Posts

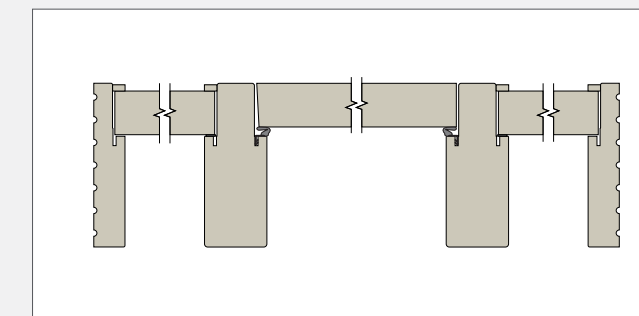

Overhang Requirements

Minimum overhang must project out at least half the distance from the bottom of the door to the base of the overhang and at least 3 feet beyond each side of the entry system.



Industry-Leading Warranty Coverage

TruStile's Wood Entry Systems come backed with industry-leading warranty coverage. Door systems that are factory finished by TruStile are warranted to be free from manufacturing defects for 5 years from date of purchase. Door systems purchased raw and unfinished are warranted to be free from manufacturing defects for 3 years from date of purchase. Due to its aging characteristics, Alder door systems are warranted for 1 year from date of purchase.

Requirements for Warranty Coverage

Your TruStile Entry Door should be viewed as a piece of well-engineered fine furniture. Careful steps have been taken to design the product to perform in proper exterior openings. However, finishes and natural wood both weather and break down over time. This weathering process increases with greater exposure to the elements. TruStile Wood Entry systems, like those sold by other manufacturers, require proper overhang protection to meet warranty requirements (*see diagram to left for details*). Proper overhang helps to protect both the finish and the natural wood from moisture and UV damage. Even with proper overhang, the topcoat of any stained natural wood door must be inspected annually and reapplied during early signs of fading. Maintaining the topcoat will maximize the life of your natural wood door and is also required to maintain TruStile warranty coverage.

TRŪSTILE®
A MARVIN  BRAND

[trustile.com](https://www.trustile.com)



1111 E 71st Avenue
Denver, CO 80229
877-283-4511